

# Geophysical Post-construction Integrity Assessment of the Subsurface Conditions of a Church Auditorium in Ado-Ekiti, Southwestern Nigeria

\*<sup>1</sup>Akinola B. Eluwole, <sup>1</sup>Temitope E. Olasupo, <sup>2</sup>Idowu O. Idowu, <sup>1</sup>Kamal O. Ibrahim and <sup>1</sup>Kolawole Ajele

<sup>1</sup>Department of Geophysics, Federal University, Oye-Ekiti, Nigeria

<sup>2</sup>6300 Ocean Dr, Corpus Christi, TX, 78412, USA

akinola.eluwole@fuoye.edu.ng | olasupotemitope17@gmail.com | olatunjidowu@yahoo.com |

kamal.ibrahim.1023@fuoye.edu.ng | kolawole.ajele.1008@fuoye.edu.ng

Received: 24-FEB-2023; Reviewed: 08-APR-2023; Accepted: 24-JUN-2023

<http://doi.org/10.46792/fuoyejet.v8i2.1009>

## ORIGINAL RESEARCH

**Abstract-** The recent obvious manifestation of rising damp, flaked plaster, blistered paint and cracks which are subtle evidences of structural distress necessitated a post-construction integrity assessment of the immediate vicinities of a church auditorium in Ado-Ekiti southwestern Nigeria. The Spontaneous Potential (SP) and Electrical Resistivity (ER) methods of geophysical prospecting were adopted for the assessment. Using a Total Field array spacing of 2 m and Dipole-dipole array spacing of 5 m respectively, SP and ER measurements were taken along three geophysical traverses. SP data were plotted as profiles of SP against distance and were filtered using the 3 periods moving average algorithm of Microsoft Excel<sup>®</sup>. Resistivity data were processed with the aid of the Dipro for Windows version 4.0 software which migrated raw field data into 2-D subsurface images. The SP profiles were interpreted semi-quantitatively by visual inspection to identify typical anomalies and their locations while ER data were interpreted quantitatively by identifying and estimating the dimensions of anomalies. Potential troughs which are typical streaming potential anomalies arising from mobile fluids within subsurface capillaries were observed on the SP profiles. Anomalously low (< 10 ohm-m) resistivity zones which are indicative of oversaturation of clay substratum cum subsurface incompetence were identified on the 2-D Electrical Resistivity Images (ERI). Synthesis of the SP profiles and 2-D images showed appreciable semblance in the interpretation of the results of both methods. It was further discovered that the identified anomalous zones delineated by the two methods were coincident on the locations of the two rear corner cracks and the rising damp, flaked plaster and blistered paint on the walls of the building. The depth to competent bedrock was found to be at about 10 m. The evidences of distress on the auditorium were suspected to be attributable to unsatisfactory/unsuitable subsurface conditions.

**Keywords-** Post-construction integrity assessment, typical anomalies, unsuitable subsurface conditions

## 1 INTRODUCTION

Geophysical methods have found use as complimentary tools for decision making in civil engineering site investigations. They are relevant as tools for pre-construction feasibility assessment of civil engineering structures (Oyediran & Falae, 2018; Teshome, 2022). Tavukçuoğlu, 2018 and Adenika *et al.*, 2018 demonstrated the use of geophysical methods in post-construction integrity assessment. On the other hand, Olorunfemi *et al.*, 2000 and Ademilua *et al.*, 2015 posited that in fact geophysical methods can be used for post-failure/post mortem studies. Olorunfemi *et al.*, 2000 investigated the failed Koza and Nassarawa Earth dams in Katsina state using the electrical resistivity and electromagnetic methods of geophysical prospecting. Zones characterized by low apparent resistivity (< 200 ohm-m) and peak positive filtered real EM anomalies which are characteristic of clayey or water saturated fissure zones were delineated beneath the Koza dam spillway foundation and the embankment. The failure of the spillway structure was therefore attributed to the seepage and natural differential settlement arising from the identified underlying clayey substratum. Conductive/low resistivity zones were also identified beneath some portions of the Nassarawa earth dam.

\*Corresponding Author

Section E- CIVIL ENGINEERING AND RELATED SCIENCES

Can be cited as:

Eluwole A.B., Olasupo T.E., Idowu O.I, Ibrahim K.O., and Ajele K. (2023). Geophysical Post-construction Integrity Assessment of the Subsurface Conditions of a Church Auditorium in Ado-Ekiti, Southwestern Nigeria, FUOYE Journal of Engineering and Technology (FUOYEJET), 8(2), 260-265. <http://doi.org/10.46792/fuoyejet.v8i2.1009>

These zones which are characteristic of fractures and joints were suspected to be seepage paths. However, the failure of the dam structure was reported to be precipitated by combinations of factors such as engineering design defects, unsuitable construction material and the identified seepage paths.

Olorunfemi *et al.*, 2004 assessed the anomalous seepage conditions in the Opa Dam Embankment. The investigation involved the Vertical Electrical Sounding (VES), dipole-dipole electrical horizontal profiling, Spontaneous Potential (SP) and magnetic profiling. The dipole-dipole and SP methods delineated zones that were suspected to be seepage zones owing to their relatively low resistivities and high streaming potentials. The amplitude of the magnetic profiles was flat for most part of the traverse, but a significant magnetic anomaly typical of a magnetic body was identified around the position of the metallic bleeding pipe within the dam embankment. Ofomola *et al.*, 2009 carried out post-foundation investigations around buildings at the staff quarters of the Federal University Technology, Akure using the electrical resistivity and Very Low Frequency Electromagnetic (VLF-EM) methods.

The study identified areas of relatively low resistivity and high conductivity as possessing clayey substratum which were suspected to precipitate the cracks and differential settlements on distressed buildings. Areas with relatively high resistivity and low conductivity were interpreted to be devoid of subsurface structures which could be inimical to stability of the foundations of buildings. Fatoba (2012) used remote sensing and geophysical methods to investigate the Shagamu-Benin Expressway.

The failed portions of the road were contiguous with zones of anomalously low resistivity on the 2-D Electrical Images with corresponding high conductivity structures on the subsurface conductivity images obtained from VLF-EM. The anomalous behaviors were attributed to subsurface geological structures such as buried stream/river channels. Meanwhile portions with near surface relatively high resistivities ( $\geq 600 \text{ ohm} - \text{m}$ ) and appreciable thickness (1.5 – 2 m) were suspected to be laterite which possessed competent characteristics with attendant road stability.

In the same vein Ademilua *et al.* (2015) in a study within the Ekiti State University, Ado-Ekiti involving the electrical resistivity and VLF-EM methods made similar observations in which zones of anomalously low resistivity generally less than 100 ohm-m with corresponding high conductivity were characteristic of incompetent clayey substratum. The study found the zones of comparatively high near-surface resistivities to also be typical of laterite around which building structures didn't manifest evidence(s) of distress. The site of a previously distressed building which was later demolished fell within the portion characterized by incompetent substratum. Omisore *et al.*, (2016) also carried out geoelectric investigations at the site of a proposed airport runway. Although geological structures such as weathered/fractured zones were identified at depths on the 2-D Electrical Resistivity images, the study concluded that the lateritic layer possessed adequate characteristics (high resistivity and appreciable thickness) that are continuous with stability and which are able to compensate for the threat(s) that may be posed by the geological structures.

Recent research carried out by Eluwole *et al.*, 2023 in the immediate vicinities of a heavily cracked academic building within the Oye Campus of the Federal University using the electrical resistivity method of geophysical prospecting also detected anomalously low resistivity to be evidently proportional to the volume of cracks around some portions of the building. On the other hand, some portions around the building that manifested competent characteristics with respect to geophysical deductions yet plagued with numerous cracks were suspected to be due to poor construction practice. The study concluded that the heavy cracks on the building are products of both incompetent subsurface and poor construction practice. Overall geophysical methods have the potential of solving some of the conventional problems associated with conventional ground investigation techniques. Because they provide a large-scale characteristic of the physical properties of the earth under undisturbed conditions, geophysical methods are generally less expensive, less invasive and less time consuming. Taking a cue from the successful use of geophysical methods in the integrity assessments of building structures, this study carried out geophysical investigations involving the spontaneous potential and the electrical resistivity methods in the immediate vicinities of a church auditorium in Ado-Ekiti, southwestern Nigeria which has been observed to be manifesting cracks, moulds, blistered paints, flaked plaster and rising damp which are known subtle

symptoms of structural distress (Plates 1a and b).

The investigation which was carried out by the Near-surface Research Group of the Department of Geophysics, Federal University Oye-Ekiti was aimed at assessing the subsurface conditions of the surroundings of the building structure in order to know the likely cause(s) of the cracks, moulds and dampness on the structure. The objectives were to: delineate subsurface geological structures which could be inimical to the foundation; estimate the depth to competent bedrock and determine the nature of the substratum.



Plate 1. Symptoms of Distress observed on the building. (a) Basal Mesh of Cracks (b) Rising damp, blistered paint and flaked plaster.

### 2.3 DESCRIPTION AND GEOLOGY OF THE STUDY AREA

The study area is located along Opopogboro Road, Adebayo area, Ado-Ekiti, The centre of the site falls within longitude  $5^{\circ} 13' 53''$  and latitude  $7^{\circ} 39' 14''$  (Figure 1). Geologically, Ado-Ekiti lies within the Precambrian Basement Complex terrain of Southwestern Nigeria, underlain by the migmatite-gneiss quartzite complex; the slightly migmatized to unmigmatized parashists and metaigneous rocks; the charnockitic, gabbroic and dioritic rocks and members of the older granite suite. From Figure 2, the migmatite-gneiss quartzite complex of Ado-Ekiti comprises migmatite and quartzite, while the charnockitic, gabbroic and dioritic group has charnockite as its representative.

On the other hand, the porphyritic granite which is the main rock unit in the study area belongs to the older granite suite. The geologic structures in this typical Basement Complex environment include faults, folds and joints (Rahaman, 1976 and Olarewaju, 1988). These structures can however be inimical to the life span of civil engineering structures. The vegetation in the area is the rainforest type, characterized by short dry season and long wet season, with high annual rainfall of about 1,300 mm. Annual mean temperature is between  $180^{\circ}\text{C}$  and  $330^{\circ}\text{C}$  with relatively high humidity (NIMET, 2007).

### 3 METHODOLOGY

Two geophysical prospecting methods were adopted for the investigation. They include the Spontaneous Potential (SP) method and the Electrical Resistivity method. The SP method measures natural earth potential usually caused by electrofiltration or streaming potential. The potential is generated from the interaction between the ions of a fluid and the wall of a capillary.



Fig. 1: Location map of the study area

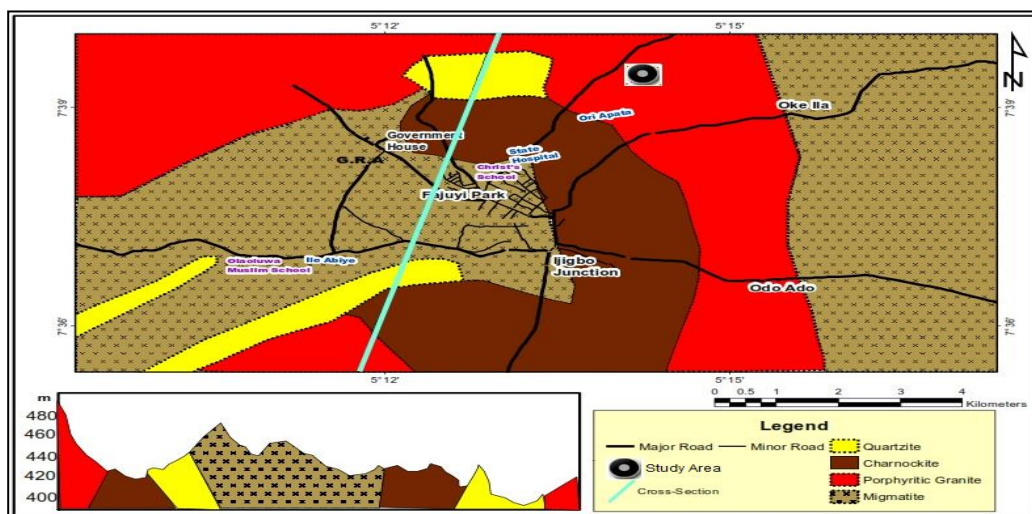

Fig. 2: Geological map of the area around the study area

The capillary in this case could be a fractured/weathered zone in which there is movement of fluids, usually water (Fatoba *et al.*, 2018). The total field array (Figure 3) of the SP method was used and measurements were predominantly taken at intervals of 2 m. On the other hand, the electrical resistivity method employs an artificial source of current which is introduced into the ground through point electrodes known as current electrodes. The resulting potential difference is measured via another pair of electrodes referred to as potential electrodes. The apparent resistivity of the ground is the product of the measured resistance and the geometric factor of the electrode array employed. The theoretical background of the method is based on the fact that the earth conducts electricity through ionic/electrolytic means, a phenomenon associated with the presence of pore fluids within the subsurface (Sabnavis and Patangay, 1998). The dipole-dipole (Figure 4) electrode configuration was used in this study. The configuration involved equidistant (electrode spacing  $a = 5$  m) and collinear pairs of current and potential electrodes which were separated by expansion factor  $n$  varying from 1 – 5. Three (3) Geophysical traverses with approximately West-East and North-South orientations were established in the immediate vicinity of the building (Figure 5). SP

and Resistivity data were acquired with the aid of the Ohmega Earth Resistivity meter. SP data were filtered using the 3 periods moving average algorithm and were plotted as profiles with Microsoft Excel®. The interpretation of SP data was semi-quantitatively done by identifying signatures and patterns characteristic of streaming potential while also estimating their locations. The resistivity field data were digitally migrated into 2-D subsurface electrical resistivity images and thereafter interpreted quantitatively with the aid of Dipro for Windows software version 4.0 (Jung-Ho, 1996).

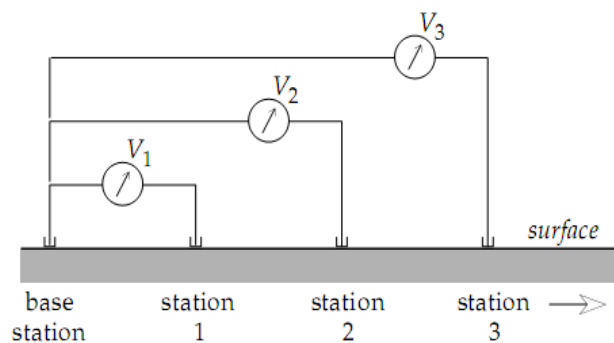

Fig. 3: The Total Field Array of the SP Method

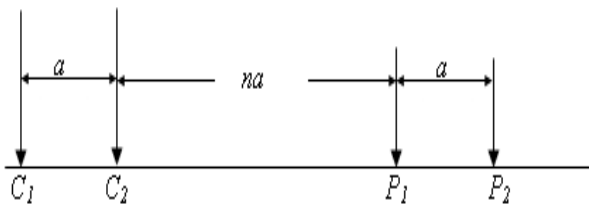

Fig. 4: The Dipole-dipole Electrode Configuration ( $C_1$  &  $C_2$ ,  $P_1$  &  $P_2$  are Current and Potential Electrodes respectively)

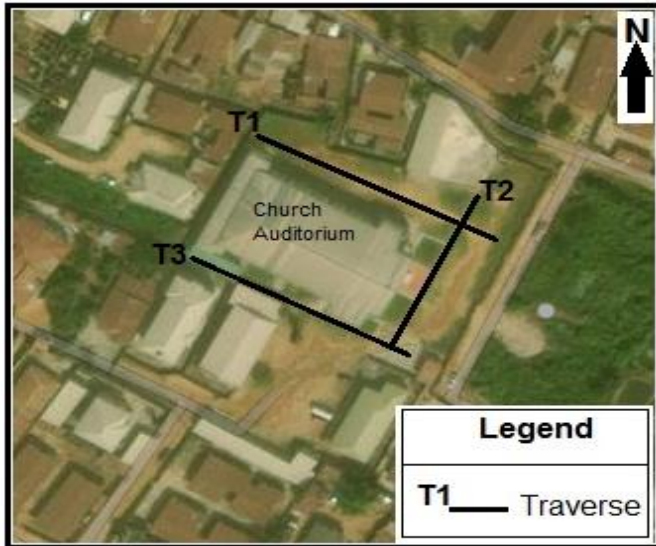

Fig. 5: Geophysical Data Acquisition Map

### 3 RESULTS AND DISCUSSION

#### 3.1 SP PROFILES

The SP data were analyzed to identify signatures/patterns that are typical of streaming potential. The average SP per traverse was used to define a threshold for each SP profile. The selected thresholds were 210 mV, 80 mV and 230 mV for Profile 1, Profile 2 and Profile 3 respectively (Figures 6a, 7a and 8a). The anomalies are spontaneous potential troughs and are identified by red arrows on each profile. One major anomaly is present on Traverse 1 (Figure 6 a). The anomaly which is suspected to be as a result of a subsurface geological structure is located between distance 18 and 24 m. Other minor anomalies such as present at distance 52 – 60 m and 66 – 80 m could be portraying the presence of clayey substratum. On Traverse 2 (Figure 7a), two major anomalies which have been superposed are present at distance 60 – 80 m. They may also have been precipitated by subsurface structures and/or clayey substratum. Also, on Traverse 3 (Figure 8a), two clearly distinguishable anomalies which are present from 6 - 10 m; and 26 – 36 are present. Similar inferences as Traverse 1 and 2 are also valid.

#### 3.1 2-D ELECTRICAL RESISTIVITY IMAGES

The 2-D ERI obtained from Traverse 1 (Figure 6b) shows anomalous resistivity characteristics indicative of weak zones (identified by red arrows) from distance 10 – 25 m with a depth extent of about 5 m. The anomalous resistivity characteristics in that zone are typical of high moisture contents from oversaturated clay materials

(Eluwole and Olorunfemi, 2012; Ademilua *et al.*, 2015; Fatoba *et al.*, 2018). Portions such as present at the 25 – 32.5 m and 60 – 75 m marks identified by yellow arrows under the greenish to yellowish colour bands on the 2-D subsurface resistivity image are also moderately saturated with mere satisfactory tendencies in terms of competence. On the other hand, areas with comparatively high resistivity values under the thick blue line are inferred to be well compacted with attendant competence as far as construction is concerned. In a typical Basement Complex environment, near surface zones with relatively high resistivities are characteristic of lateritic soils which are known to have good load bearing capacity. Fatoba, 2012 and Omisore *et al.*, 2016 found that lateritic soils having appreciable thickness (>1.5 m) are able to bear loads imposed by civil engineering structures conveniently.

On Traverse 2 (Figure 7b), pockets of oversaturated weak zones are present within the moderately saturated-satisfactorily competent and the compacted-competent zones. The depth to bedrock beneath both Traverse 1 and Traverse 2 is about 10 m, however there exists a basement depression beneath the 45 – 60 m mark on Traverse 2.

#### 3.2 SYNTHESIS OF RESULTS

By juxtaposing the results of the geophysical methods adopted, there exist consistencies in their results. This is because positions of anomalous zones on the SP profiles correspond with the identified zones of weakness on the 2-D resistivity images (Figure 6 a & b and Figure 7 a & b).

The positions of the identified zones of weakness were tied to the building structure and it was observed that the major anomaly on Traverse 1 (Figure 6 a & b) had close proximity with the major crack on the rear corner of the building (Figure 6 c). On Traverse 2 (Figure 7 a-c) however, the portion of the building manifesting blistered paints, flaked plaster and rising damp was found to be in the vicinity of the weak/satisfactory zones. In the same vein, one of the major SP anomalies observed on Traverse 3 (Figure 8) is coincident on the location of the crack on the second rear corner of the building.

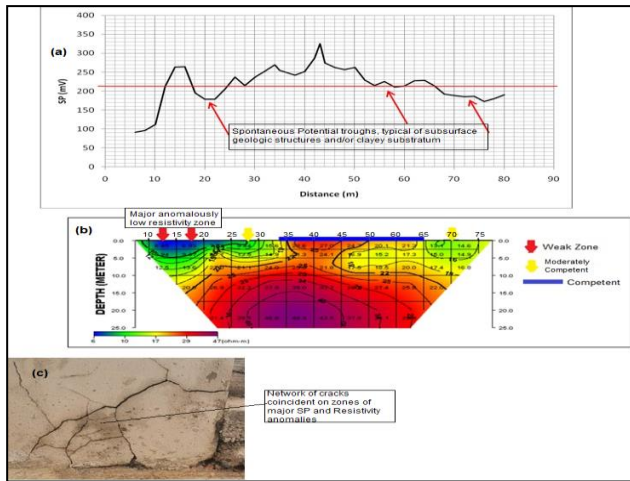

Fig. 6: Results from Traverse 1. (a) Spontaneous Potential Profile (b) 2-D Subsurface Electrical Resistivity Image (c) Network of cracks on the rear corner of the building.

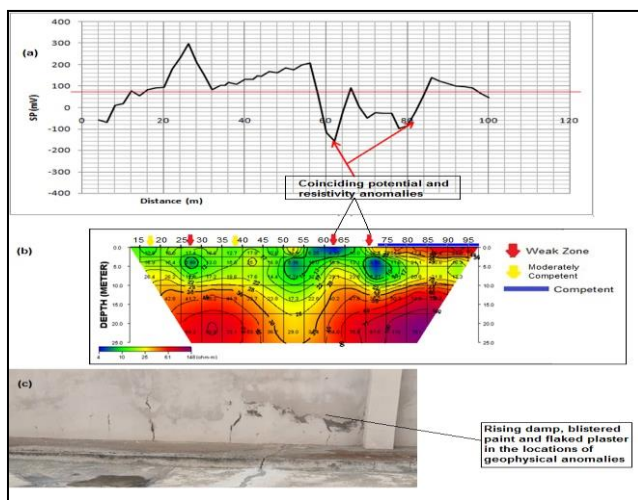

Fig. 7: Results from Traverse 2. (a) Spontaneous Potential Profile (b) 2-D Subsurface Electrical Resistivity Image (c) A portion of the building manifesting symptoms of distress.

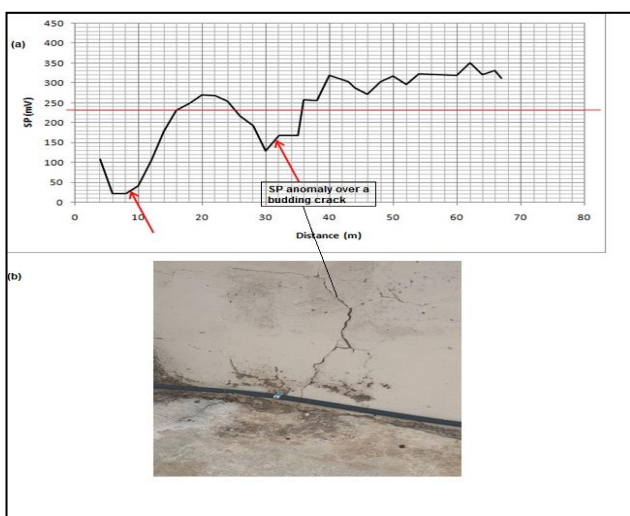

Fig. 8: Results from Traverse 3 (a) Spontaneous Potential Profile (b) 2-D Subsurface Electrical Resistivity Image (c) A budding crack

### 4 CONCLUSION AND RECOMMENDATION

The study was able to successfully evaluate the subsurface conditions of the study site through geophysical measurements. Portions identified with anomalous conditions were found to correspond with parts of the building having evidences of distress.

In conclusion, the evidences of distress observed on the building structure could have been precipitated by subsurface incompetence resulting from moderately saturated to oversaturated characteristics. The cracks are products of differential settlement dictated by the incompetent clay substratum. The rising damp and flaked plaster are due to upward movement of water from the subsurface through capillary effect.

To further enhance the integrity of the building and extend its lifespan, the rear corner cracks can be corrected by underpinning to ensure the loads of the corners are transmitted to the competent bedrock. The rising damp, flaked plaster and blistered paint can be treated by secondary damp-proofing or damp coursing.

### REFERENCES

Ademilua, O. L., Eluwole, A. B., & Bawallah, M. (2015). Geophysical Investigations for Subsurface Integrity Assessment and Its Implications on Existing and Proposed Buildings Around the Southwestern Part of the Ekiti State University Campus, Ado-Ekiti, Southwest Nigeria. *International Journal of Advancement in Engineering Technology, Management and Applied Science*, 1 (3), 1-10.

Adenika, C. I., Ariyibi, E. A., Awoyemi, M. O., Adebayo, A. S., Dasho, O. A., & Olagunju, E. O. (2018). Application of geophysical approach to highway pavement failure: a case study from the basement complex terrain southwestern Nigeria. *International Journal of Geo-engineering*. <https://doi.org/https://doi.org/10.1186/s40703-018-0076-0>

Eluwole, A. B., & Olorunfemi, M. O. (2012). Time-lapsed geophysical investigation of the Mokuro Earth Dam Embankment, Southwestern Nigeria, for anomalous seepages. *Pacific Journal of Science and Technology*, 13 (1), 604-614.

Fatoba, J. O. (2012). *Geoelectric, Geotechnical and Remote Sensing Investigations of Flexible Highway Pavement Failure along Shagamu-Benin Expressway, Southwestern Nigeria*. Unpublished PhD Thesis, Obafemi Awolowo University, Ile-Ife, Geology.

Fatoba, J. O., Eluwole, A. B., Ademilua, O. L., & Sanuade, O. A. (2018). Evaluation of subsurface conditions by geophysical methods at Ureje Earth Dam Embankment, Ado-Ekiti, Southwestern Nigeria – A case study. *Indian Journal of Geosciences*, 72 (4), 275-282.

Jung-Ho, K. (1996). *Patent No. Dipro for Windows Version 4.0*. Hee Song Geotek Co.

Nigeria Meteorological Agency. (2007). Daily weather forecast on the Nigerian Television. Lagos.

Ofomola, M. O., Adiat, K. A., Olayanju, G. M., & Ako, B. D. (2009). Integrated Geophysical Methods for Post Foundation Studies, Obanla Staff Quarters of the Federal University of Technology, Akure, Nigeria. *Pacific Journal of Science and Technology*, 10 (2), 93-111.

Olarewaju, V. O. (1988). Charnockitic and associated Granitic rocks of Ado-Ekiti-Akure, S.W. Nigeria. *Precambrian Geology of Nigeria*, 129-143.

Olorunfemi, M. O., OJO, J. S., Sonuga, F. A., Ajayi, J. O., & Oladapo, M. I. (2000). Geophysical Investigation of Karkaku Earth Dam Embankment. *Global Journal of Pure and Applied Science*, 13 (1), 117-124.

- Olorunfemi, M.O., Idornigie, A.I., Fagunloye, H.O., & Ogun, O.A. (2004). Assessment of Anomalous Seepage Conditions in the Opa Dam Embankment, Ile-Ife, Southwestern Nigeria. *Global Journal Geological Sciences* 2(2), 191-198.
- Omisore, B. O., Olorunfemi, M. O., & Jin, M. (2016). Geoelectric investigation of a proposed Mambilla Plateau Airport Runway, Taraba State, Nigeria. *7th International Conference on Environment and Engineering Geophysics & Summit Forum of Chinese Academy of Engineering on Engineering Science and Technology*. <https://doi.org/10.2991/iceeg-16.2016.66>.
- Oyediran, I. A., & Falae, P. O. (2018). Integrated Geophysical and Geotechnical Methods for Pre-Foundation Investigations. In *Journal of Geology & Geophysics* 8(1). <https://doi.org/10.4172/2381-8719.1000453>
- Tavukçuoğlu , A. (2018). Non-Destructive Testing for Building Diagnostics and Monitoring: Experience Achieved with Case Studies. *MATEC Web of Conferences*. 149, 1–8. EDP sciences. <https://doi.org/https://doi.org/10.1051/mateconf/201814901015>
- Teshome, A. M. (2022). Application of Magnetic Method to Characterize Abaya Campus Building Site, Southern Ethiopia. *Journal of Geology & Geophysics*. 11 (1), pp. 1–5). <https://doi.org/DOI: 10.35248/2381-8719-22.11.1013>
- Rahaman, M. A. (1978). Review of the Basement Geology of Southwestern Nigeria. *Geology of Nigeria*, 23-33.
- Sabnavis, M., & Patangay, N. S. (2006). *Principles and Applications of Groundwater* . Hyderabad, India.: Association of Exploration Geophysicists.